

RSIC-V INSTALLATION GUIDE
RSIC-V SOUND ISOLATION CLIP



RSIC-V



RSIC-V SOUND ISOLATION CLIP

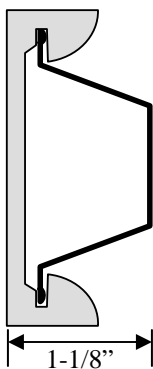
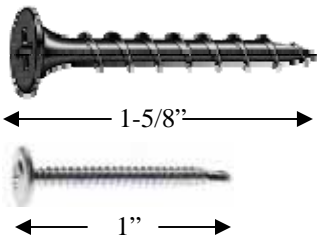
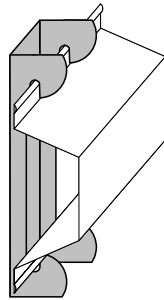
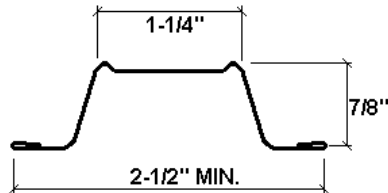

Furring Channel:

- **Minimum requirements:** 25 gauge, hemmed edge detail required on all 25 gauge furring channel. Meets or exceeds SSMA min. requirements. (25 Ga furring channel recommended)
- **Depth:** 7/8 inch
- **Width Bottom:** 2-1/2 inch wide minimum.
- **Width Top:** 1-1/4 inch wide

7/8" Splice drywall furring channel (hat track) with 6 inch overlap in mid span (between two clip) secure with 18 Ga tie wire, or two 7/16" framing screws.

Resilient Sound Isolation Clip (RSIC-V)

- **Spacing:** maximum 48 inches on center
- **Maximum acoustical design load:** 36 lbs

Fasteners:

- **RSIC-V to wood:** 1-5/8 inch minimum size coarse thread screw
- **RSIC-V to Steel:** 9/16 inch minimum size fine thread screw
- For 25 gauge Steel Studs use 9/16" x #8 shank needle point, wafer head framing screw to attach the RSIC-V to the framing members
- DO NOT fasten Resilient Sound Isolation Clips (RSIC-V) to framing members with nails. Use only approved screws.

RSIC-V dimensions:

- RSIC-V clip 3" tall
- RSIC-V and 7/8" Drywall Furring Channel 1-1/8" deep

Average Labor Rates:

- **RSIC-V:** 72 clips per man hour
- **Drywall Furring Channel:** 550LF per man hour

Labor rates provided to PAC International, Inc by independent contracting firm

RSIC-V SOUND ISOLATION CLIP

WALLS: One and Two layer of 5/8" gypsum

- Resilient Sound Isolation Clips (RSIC-V) shall be 48 inches maximum on center . (horizontal)
- Fasten the Resilient Sound Isolation Clip (RSIC-V) to the substrate with a fastener approved for a minimum pull-out and shear of 120 lbs.
- Ensure the RSIC-V clip is tight to the substrate.
- Locate the first row of RSIC-V clips within 3 inches from the floor and within 6 inches from the ceiling.
- Snap in the drywall furring channel (hat track) into the RSIC-V clips (horizontal for walls). (see page 2 for splice details)
- Place 1/4" (minimum) shim on floor to fully support the gypsum board.
- Install the gypsum board from the bottom up leaving a 1/4" min. gap around perimeter of wall.
- ONLY remove the shims after ALL the gypsum board is completely screwed to ALL the drywall furring channels.
- Make sure every screw (floor to ceiling and wall to wall) is installed as required by the assembly design, in every layer of gypsum board before removing the shims at the floor. The shims are critical to ensure best results.
- Caulk around the perimeter of the wall. Use fire and smoke rated acoustical sealant where required.

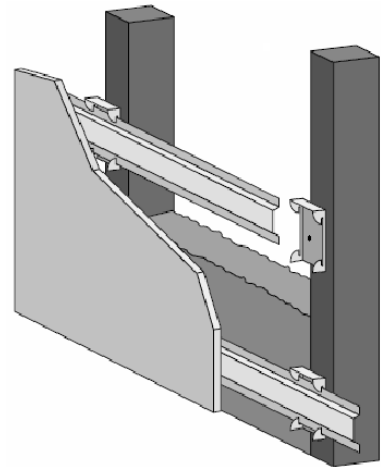

Ceilings: One and Two layer 5/8" gypsum

- Resilient Sound Isolation Clips (RSIC-V) shall be 48 inches maximum on center .
- Fasten the Resilient Sound Isolation Clip (RSIC-V) to the substrate with a fastener approved for a minimum pull-out and shear of 120 lbs.
- Ensure the RSIC-V clip is tight to the substrate.
- Locate the first row of RSIC-V clips within 8 inches of the wall at each end of a run
- Snap in the drywall furring channel (hat track) into the RSIC-V clips.
- Install the gypsum board leaving a 1/4" min. gap around perimeter of the ceiling.
- Caulk around the perimeter of the ceiling. Use fire and smoke rated acoustical sealant where required.

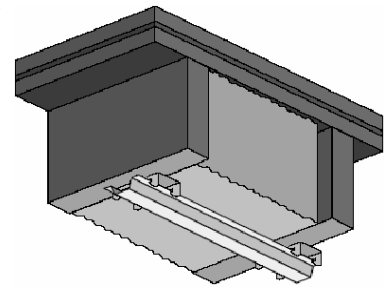

General Information:

- Refer to www.UL.com for complete installation details on all fire resistive assembly designs.
- Resilient Sound Isolation Clip (RSIC-V), furring channel (hat track) and gypsum board shall not carry heavy loads such as cabinets or bookshelves.
- Splice furring channel (hat track) with 6 inch overlap in mid span, secure with 18 ga. tie wire or with two framing screws (7/16")
- Seal all potential air leaks with non-hardening acoustical caulking to achieve best noise control results. Use fire rated sealant where required.
- When attaching the RSIC-V clips to a steel stud the minimum allowable thickness is 20 ga. (0.030). 3 fasteners are required to secure the RSIC-V to 25 ga framing.

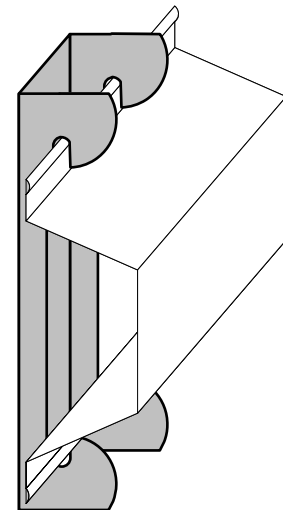

Fire Test Information:

Approved for use in over 160 different UL fire resistive design assemblies. Check our website for the latest updates of the fire testing approvals. Check UL Fire Resistance Directory File # R16638 Check UL's web pages. www.ul.com/database Contact UL (877) UL-HELPS



RSIC-V SOUND ISOLATION CLIP

APPLICATION RECOMMENDATIONS FOR WALLS AND CEILINGS, WOOD OR STEEL FRAMING

INSTALLING RESILIENT SOUND ISOLATION CLIPS (RSIC-V)

RSIC CLIPS AT 24" OC.

RSIC-V Wall or Ceiling System Framing at 24" o.c.

RSIC-V clips at 24" x 48" o.c. 1 or 2 Layers of 5/8" Gypsum Board

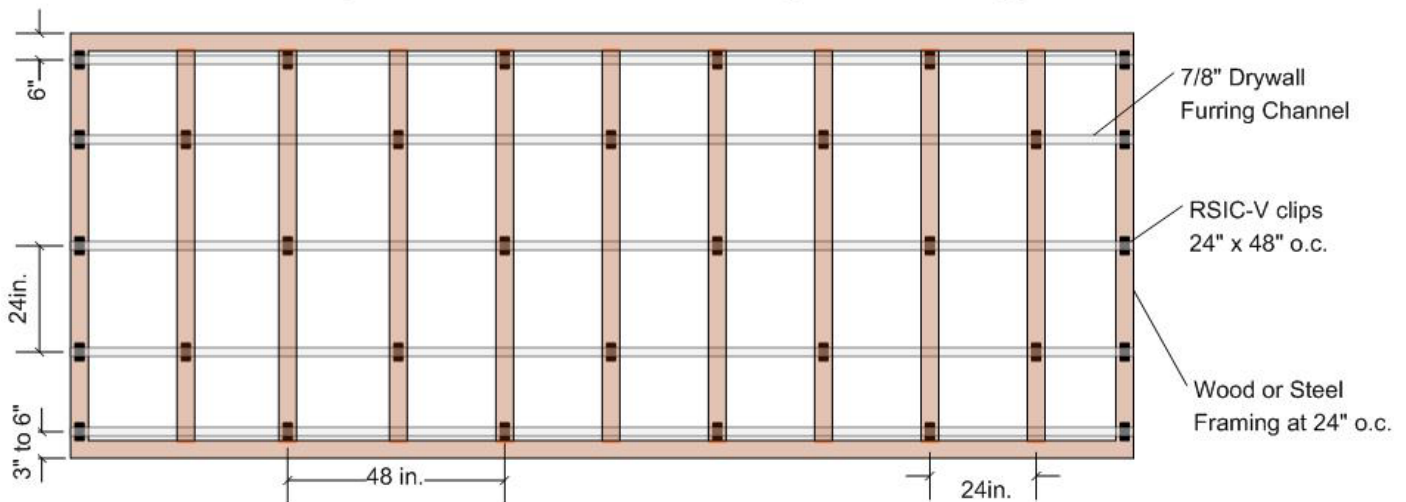

RSIC-V Wall or Ceiling System Framing at 16" o.c.

RSIC-V clips at 24" x 48" o.c. 1 or 2 Layers of 5/8" Gypsum Board

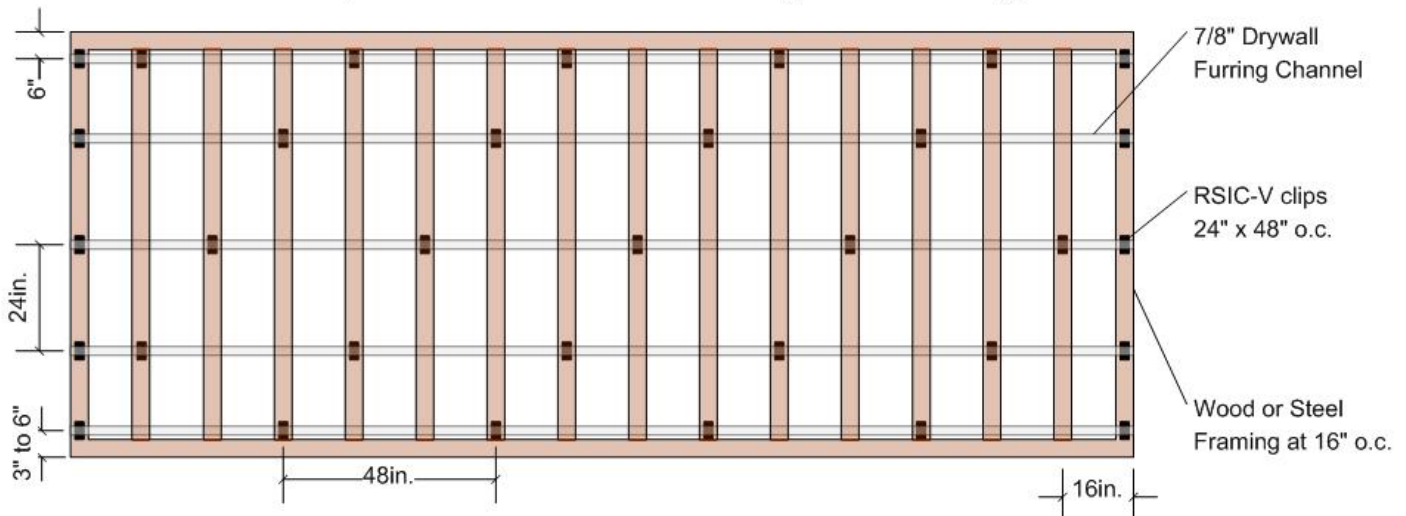

RSIC-V SOUND ISOLATION CLIP

APPLICATION RECOMMENDATIONS FOR WALLS AND CEILINGS, WOOD OR STEEL FRAMING

INSTALLING RESILIENT SOUND ISOLATION CLIPS (RSIC-V)

RSIC CLIPS AT 16" OC.

RSIC-V Wall or Ceiling System Framing at 24" o.c.

RSIC-V clips at 16" x 48" o.c. 3 Layers of 5/8" Gypsum Board

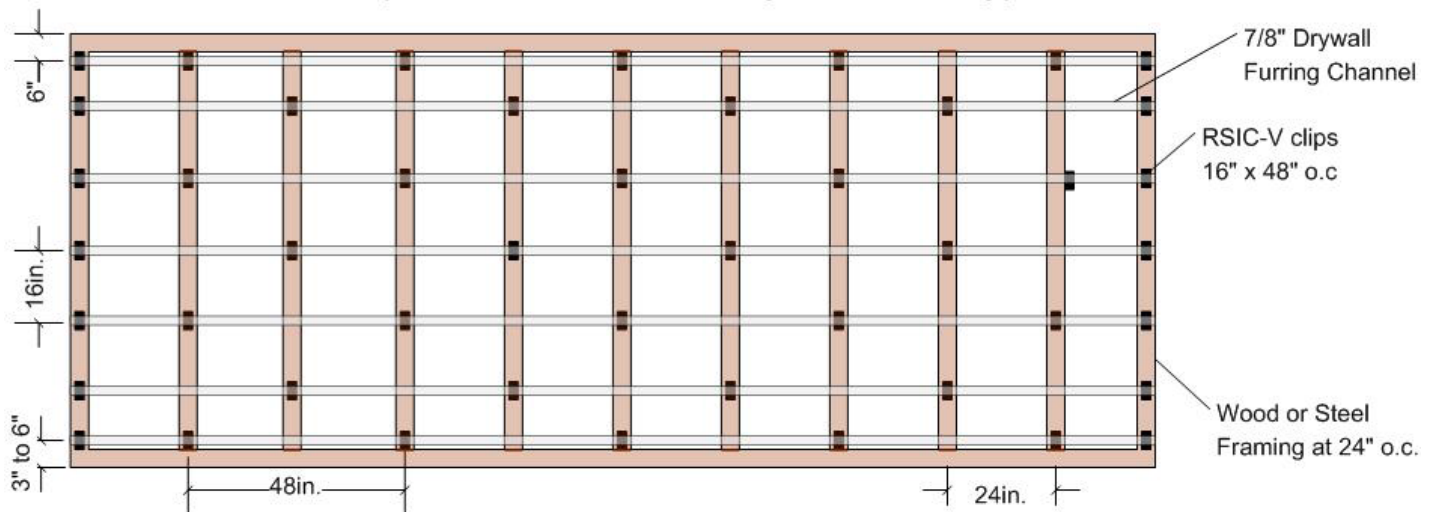

RSIC-V Wall or Ceiling System Framing at 16" o.c.

RSIC-V clips at 16" x 48" o.c. 3 Layers of 5/8" Gypsum Board

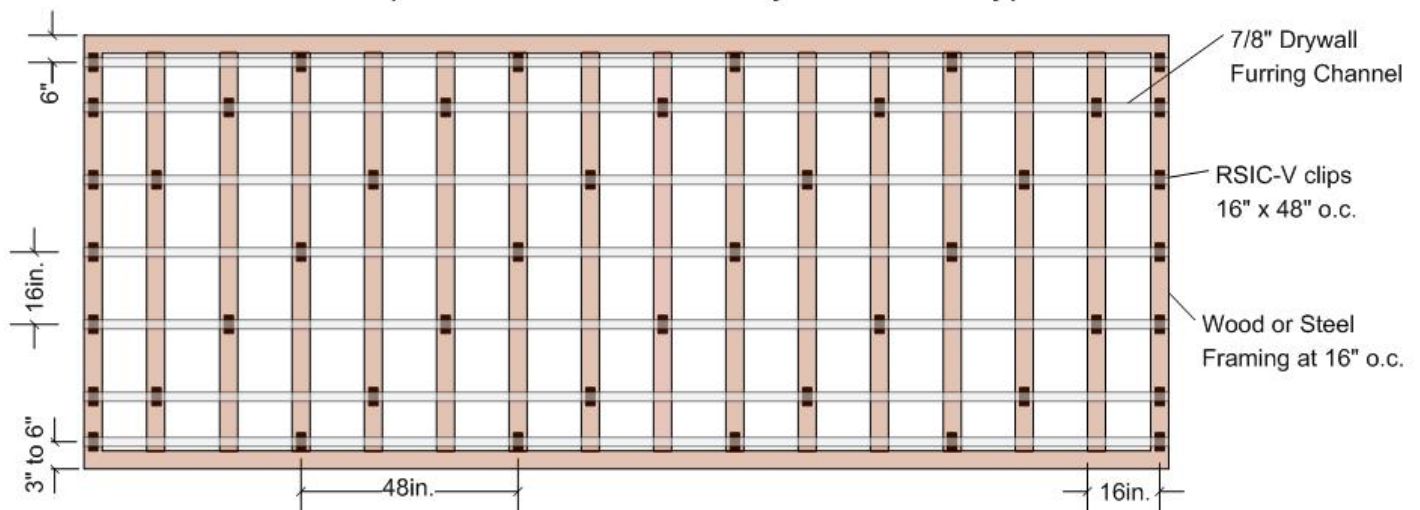

RSIC-V SOUND ISOLATION CLIP



The RSIC-V is the first and only product classified by UL for both fire and sound.

Members of the International Code Council

WARRANTY DISCLAIMER AND LIABILITY LIMITATION LANGUAGE

NO EXPRESS OR IMPLIED WARRANTIES

THERE IS NO WARRANTY, REPRESENTATION OR CONDITION OF ANY KIND; AND ANY WARRANTY, EXPRESS OR IMPLIED, IS EXCLUDED AND DISCLAIMED, INCLUDING THE IMPLIED WARRANTIES OF MERCHANTABILITY AND OF FITNESS FOR A PARTICULAR PURPOSE. Some states do not allow limitations on implied warranties, so the above limitation may not apply to you.

LIABILITY LIMITED TO RETURN OF PURCHASE PRICE

IT IS AGREED THAT SELLER'S LIABILITY AND PURCHASER'S SOLE REMEDY, WHETHER IN CONTRACT, UNDER ANY WARRANTY, IN TORT (INCLUDING NEGLIGENCE), IN STRICT LIABILITY OR OTHERWISE, SHALL NOT EXCEED THE RETURN OF THE AMOUNT OF THE PURCHASE PRICE PAID BY PURCHASER, AND UNDER NO CIRCUMSTANCES SHALL SELLER BE LIABLE FOR ANY SPECIAL, INCIDENTAL OR CONSEQUENTIAL DAMAGES, INCLUDING, BUT NOT LIMITED TO, PERSONAL INJURY, PROPERTY DAMAGE, DAMAGE TO OR LOSS OF EQUIPMENT, LOST PROFITS OR REVENUE, COSTS OF RENTING REPLACEMENTS AND OTHER ADDITIONAL EXPENSES, EVEN IF SELLER HAS BEEN ADVISED OF THE POSSIBILITY OF SUCH DAMAGES. THE PRICE STATED FOR THE EQUIPMENT IS A CONSIDERATION IN LIMITING SELLER'S LIABILITY AND PURCHASER'S REMEDY. Some states do not allow the exclusion or limitation of incidental or consequential damages, so the above limitation or exclusion may not apply to you.

SELLER NOT LIABLE FOR PURCHASER'S NEGLIGENCE

SELLER WILL NOT BE LIABLE FOR ANY DAMAGES, LOSSES OR EXPENSES AS A RESULT OF PURCHASER'S NEGLIGENCE, WHETHER DEEMED ACTIVE OR PASSIVE AND WHETHER OR NOT ANY SUCH NEGLIGENCE IS THE SOLE CAUSE OF ANY SUCH DAMAGE, LOSS OR EXPENSE.

MODEL FOR DEMONSTRATION PURPOSES ONLY

THE MODEL OR SAMPLE SHOWN BY SELLER TO BUYER IS USED FOR DEMONSTRATION PURPOSES ONLY. THERE IS NO WARRANTY THAT THE GOODS AS DELIVERED SHALL CONFORM TO THE MODEL OR SAMPLE, AND CONFORMITY OF THE GOODS TO THE MODEL OR SAMPLE IS NOT PART OF THE BASIS OF THE BARGAIN BETWEEN SELLER AND BUYER.

NO WARRANTY OR COMPLIANCE WITH SAFETY CODE OR REGULATION

SELLER DOES NOT WARRANT THAT ANY OF THE GOODS SOLD WILL MEET OR COMPLY WITH THE REQUIREMENTS OF ANY SAFETY CODE, BUILDING OR DWELLING CODE, OR REGULATION OF ANY STATE, MUNICIPALITY OR OTHER JURISDICTION.

OREGON LAW APPLIES

SELLER AND BUYER AGREE THAT ALL ASPECTS OF THIS TRANSACTION INCLUDING THE APPLICABLE STATUTE OF LIMITATIONS SHALL BE GOVERNED BY THE INTERNAL LAW OF THE STATE OF NEVADA, AND NOT THE LAWS OF CONFLICTS. This warranty gives you specific legal rights, and you may also have other rights which vary from state to state.